

# INSTALLING A WINE AS ART WINEPANEL™

## PRODUCT OVERVIEW

Wine As Art WinePanel™ is a wine display system that stores wine on hardware, mounted to a decorative panel. The decorative top-panel sits proud of the structural back-panel.

The back-panel is secured to a wall with screws or anchors.

2" set-screws, supplied with driver, are drilled into the back-panel by the installer.

The decorative panel is installed over the set-screws and the Wine Hardware is threaded onto the set-screws, sandwiching the decorative panel between the back-panel and the hardware.

The weight of the wine bottles is transferred to the structural back-panel.

Carefully observe the disclaimer and warranty and have a full understanding of the application and limitations of the WinePanel™.

## Supplied with Wine As Art WinePanel™ system:

- Installation template showing hole patterns for wine hardware and fasteners
- Back-panel, pre-drilled for all hardware options and pilot holes for anchors
- Wood screws for back-panel
- Decorative top-panel
- 1/4"-20 x 2" set-screws
  - (18) for Peg
  - (6) for Post
  - 1/8" hex driver for set screws
- Plastic washers
- Plastic wall anchors with instruction

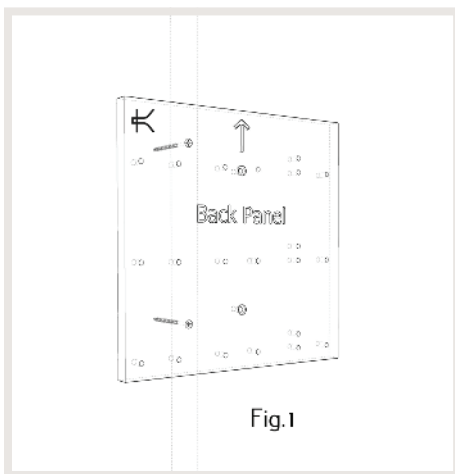

Fig.1

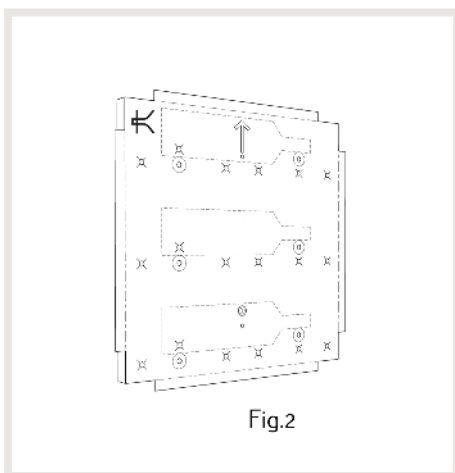

Fig.2

## Tools needed:

- Drill/driver
- Drill bit 3/16"
- Level
- Pencil
- Tape measure
- Stud finder

## Installation:

1. Determine where you are going to mount the WinePanel™.
2. Use stud-finder to locate wood stud(s) and mark center of stud(s). \*Fig1
3. Install the back-panel onto the wall with supplied fasteners.
  - a. Whenever possible, secure with screws directly into wood stud.
    - i. Drive one screw, level the sub-panel and drive the final screwsOR
  - b. If wood studs are not an option:
    - i. Use the pre-drilled holes in the back-panel to mark the pilot holes for the hollow wall anchors on the wall.
    - ii. Follow manufacturer's instructions to install supplied hollow wall anchors.
4. Using the WinePanel™ design and installation template, determine whether you are installing Posts or Pegs on the panels. \*Fig2
  - a. **Posts are label forward** wine display (see fig 3)
    - i. 6 Posts (3 pairs) per 14" panel
    - ii. Reference design to determine 1,2 or 3 deep Post
  - b. **Pegs are neck-out** wine display (see fig 4)
    - i. 18 pieces (9 pairs) per 14" panel

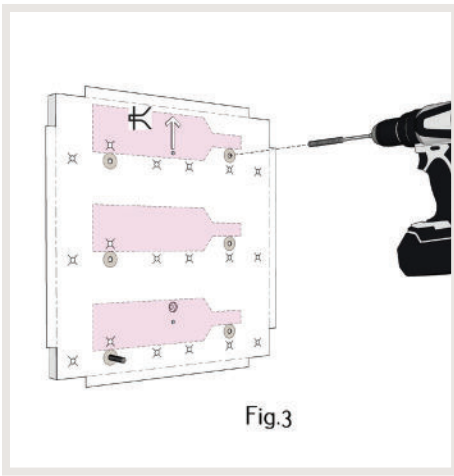

Fig.3

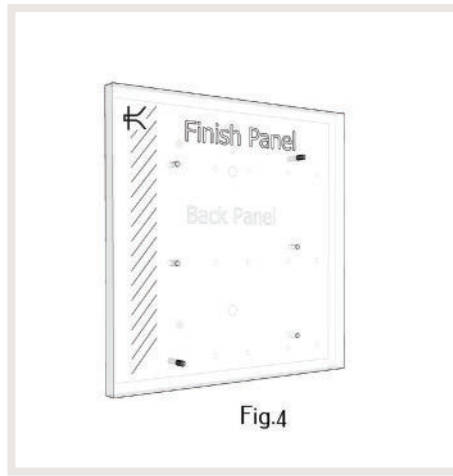

Fig.4

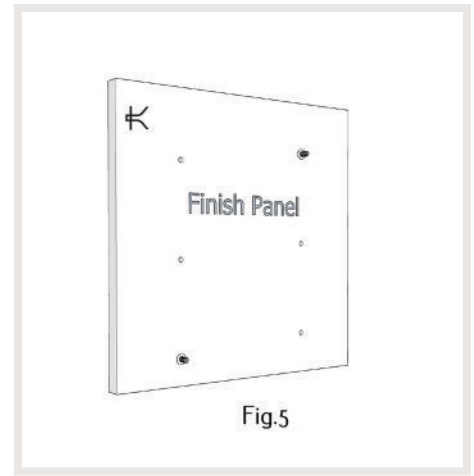

Fig.5

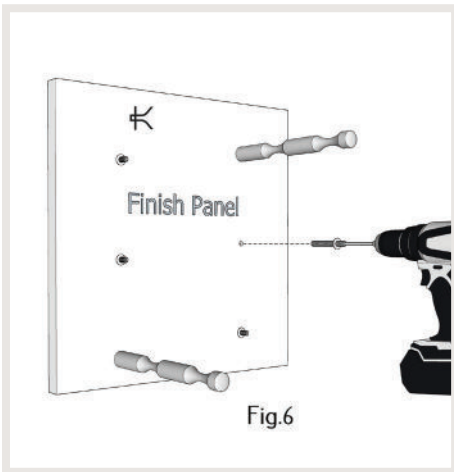

Fig.6

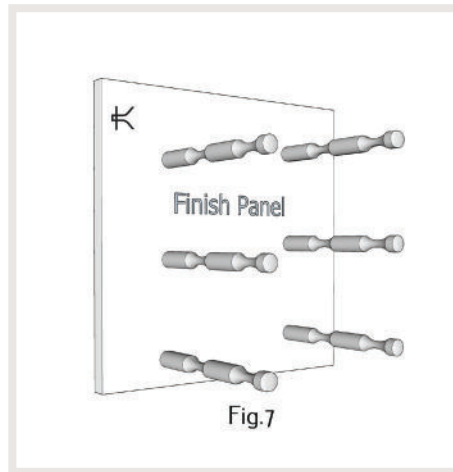

Fig.7

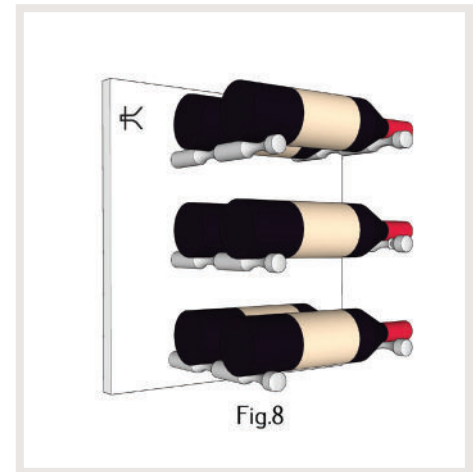

Fig.8

5. Using a drill with supplied driver, install (2) set-screws per panel. **\*Fig3**
  - a. Note: for 14x14, 14x28 and 14x42, initially install only (2) screws total per back-panel
  - b. Drive the set-screws into the back-panel 5/8" to 3/4" deep, leaving 1-1/4" to 1-3/8" protruding out of the back-panel.
    - i. Note: do not overdrive the set-screws through the back-panel into the wall
    - ii. Note: do not overdrive the set-screws through the back-panel into the wall
6. Install the decorative top-panel over the (2) set screws. **\*Fig4**
7. Install a supplied plastic washer over each of the two set screws. **\*Fig5**
8. Hand-thread the hardware sandwiching the washer between the hardware and the decorative top-panel.
  - a. Snug, but not too tight.
  - b. Then level decorative top-panel and hand tighten the hardware to hold the panels in the correct position.
9. Drive the remaining set screws through the decorative panel holes into the structural back-panel leaving 1/2" to 5/8" protruding out of decorative top-panel. **\*Fig6**
10. Install the plastic washers over the remaining set screws.
11. Thread and hand tighten the rest of the wine hardware according to design. **\*Fig7**
12. Stock your new Wine As Art WinePanel™ with wine and enjoy. **\*Fig8**

